

AURA LED

IP
66IK
09

Modern decorative outdoor LED lamp for lighting boulevards, pedestrian routes, bicycle paths and residential area

DISTRIBUTION CURVE

AURA LED 34W

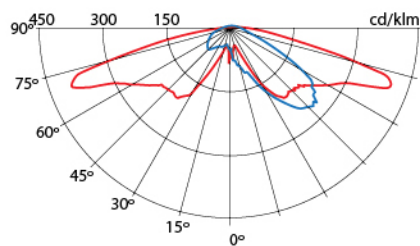

— 0°/180° — 90°/270°

AURA LED 51W

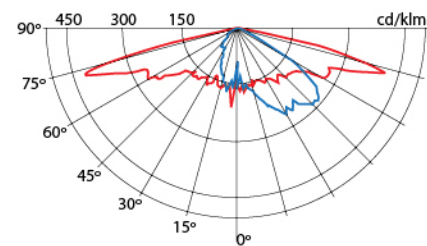

— 0°/180° — 90°/270°

DIMENSIONS

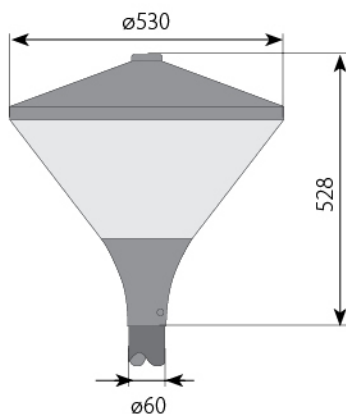



ADVANTAGES

- made of aluminum cast
- optical system in lenticular technology, mounted inside the luminaire
- prismatic cover resistant to impact
- optical system made in a modular form
- interchangeable lenses to achieve optimal lighting parameters



TECHNICAL DATA



Nominal luminous flux

LED number	AURA LED		
	16 LED	24 LED	32 LED
Current 350mA	Luminous flux (lm)	2877	4316
	Power (W)	17	25
Current 500mA	Luminous flux (lm)	3826	5740
	Power (W)	24	36
Current 700mA	Luminous flux (lm)	5380	8070
	Power (W)	34	51
Current 1000mA	Luminous flux (lm)	7193	-
	Power (W)	50	-
 Surface of wind exposure (CxS)		0,10 m ²	
 Weight of the luminaire		4,5 kg	

• Due to the optical systems and LED drivers used, differences of ± 8% luminous flux and power of the luminaire are allowed.
 • The given parameters are examples as it is possible to adjust the supply current and change the luminaire power and luminous flux.
 • Due to continuous development of LED technology, the parameters may change. • To get the latest information, please contact the company.

 LED Chip
CREE XP-G3
 CCT
 2700-6500K
 CRI
 CRI ≥ 70

 $\cos \phi$ min. 0,95
 from -40°C to +60°C

 100 000 h
 IES LM80-L90B10
 9007

EASY AND SAFE MAINTENANCE

- maintenance without tools

ADDITIONAL OPTIONS

- adjustable current in the range of 350-1050mA
- ability to adjust the power and luminous flux optimally to the project
- autonomic power control (Astro DIM)
- possibility of remote control and monitoring (DALI)
- step, remote or autonomic power control (STEP DIM)
- phase wire control (SD)
- working with light/motion sensors
- surge protection up to 10 kV
- overload or thermal protection
- soft-start – limitation of inrush current
- optional equipment – ZHAGA or NEMA socket

